

DEVON

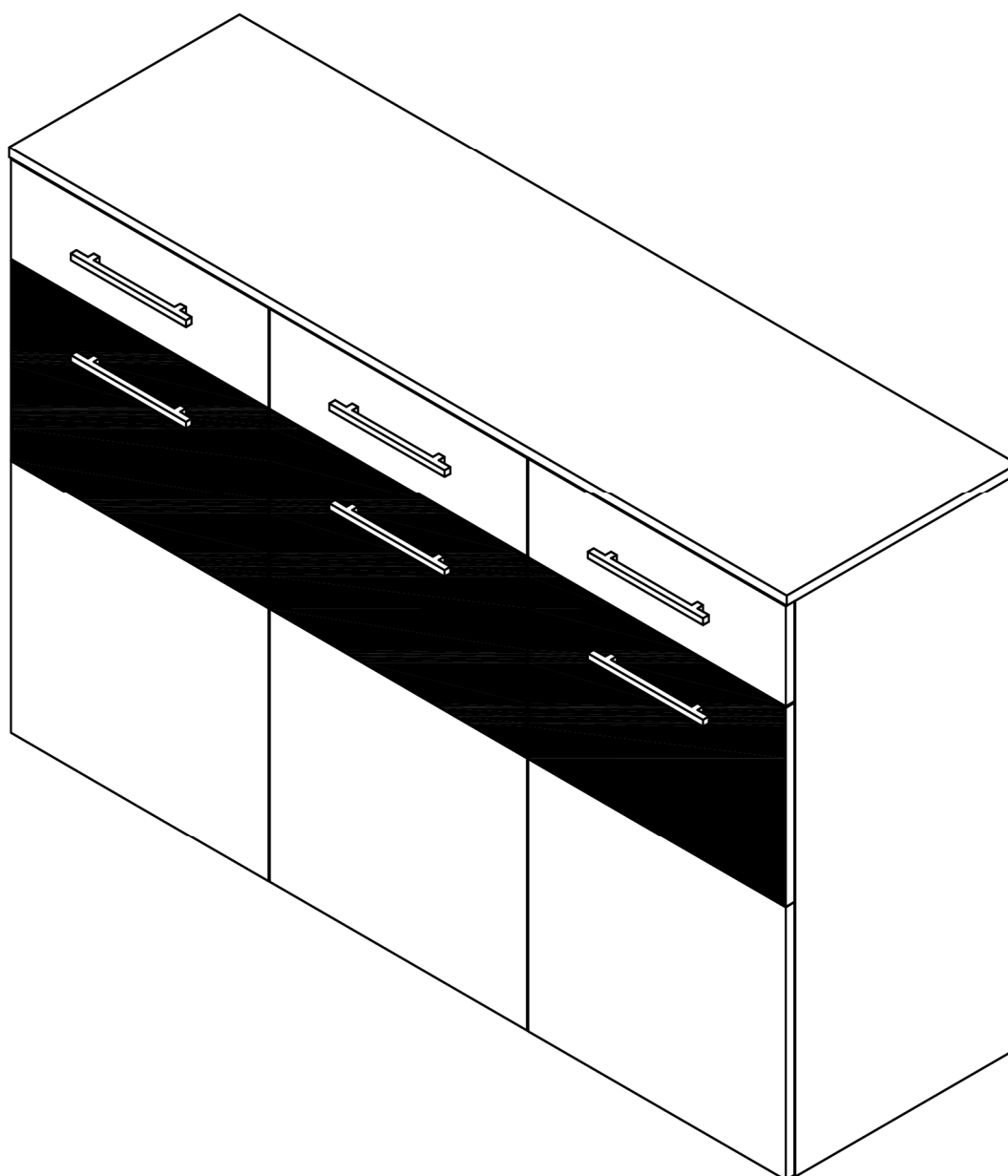

W przypadku braku lub uszkodzenia jakiegos elementu najszybszym sposobem zlozenia reklamacji jest kontakt ze sklepem, w ktorym towar zostal zakupiony.

Przy skladaniu reklamacji nalezy podac:

- nazwe wyrobu
- data instrukcji z pierwszej strony
- numer elementu lub okucia
- ilosc brakujacych elementow lub okuc
- kolor wyrobu
- dowod zakupu
- Twoje dane osobowe

UWAGA! Uszkodzonych elementow nie montowac.

Data: 2015-11-25

1

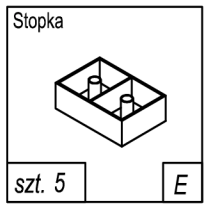
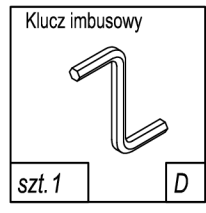
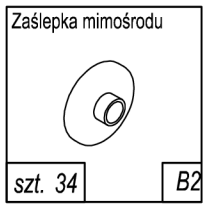
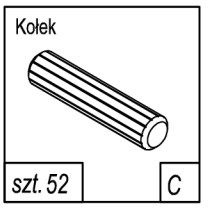
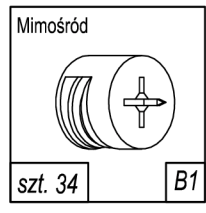
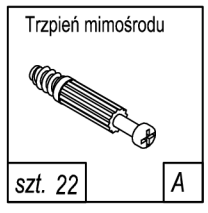
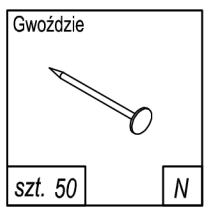
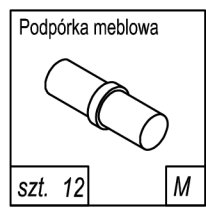
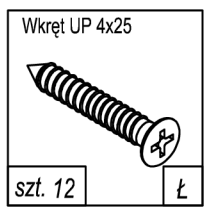
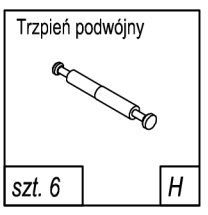
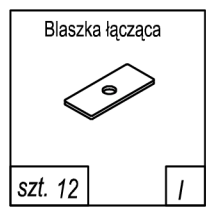
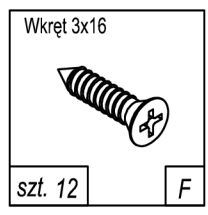
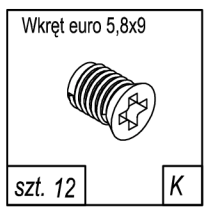
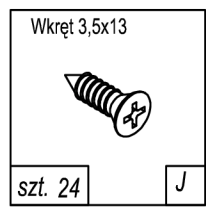
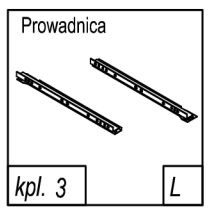
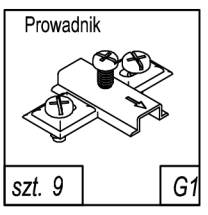
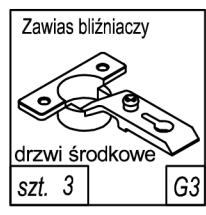
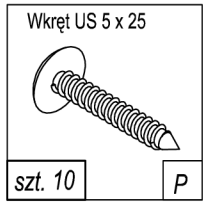
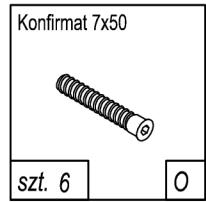
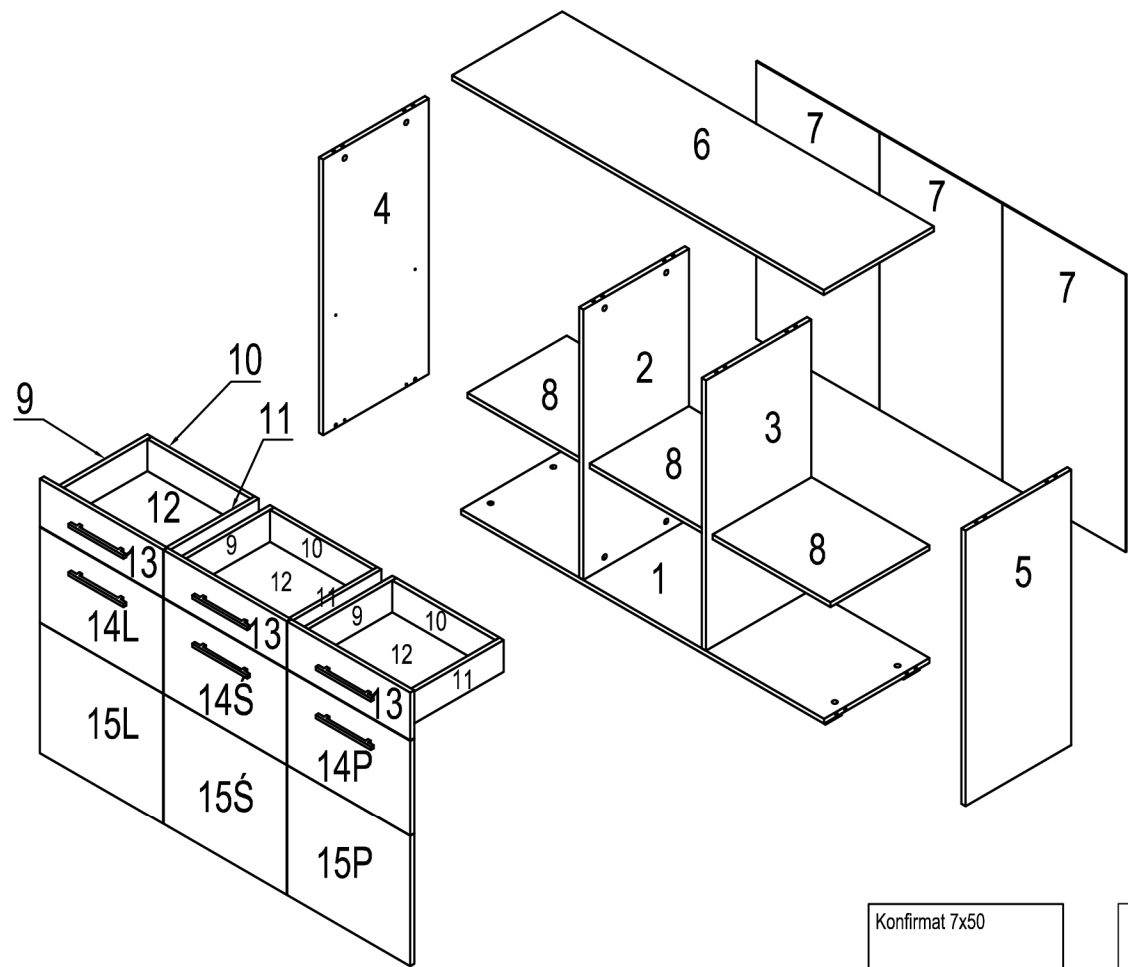
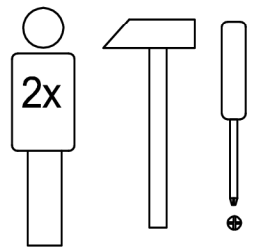

2

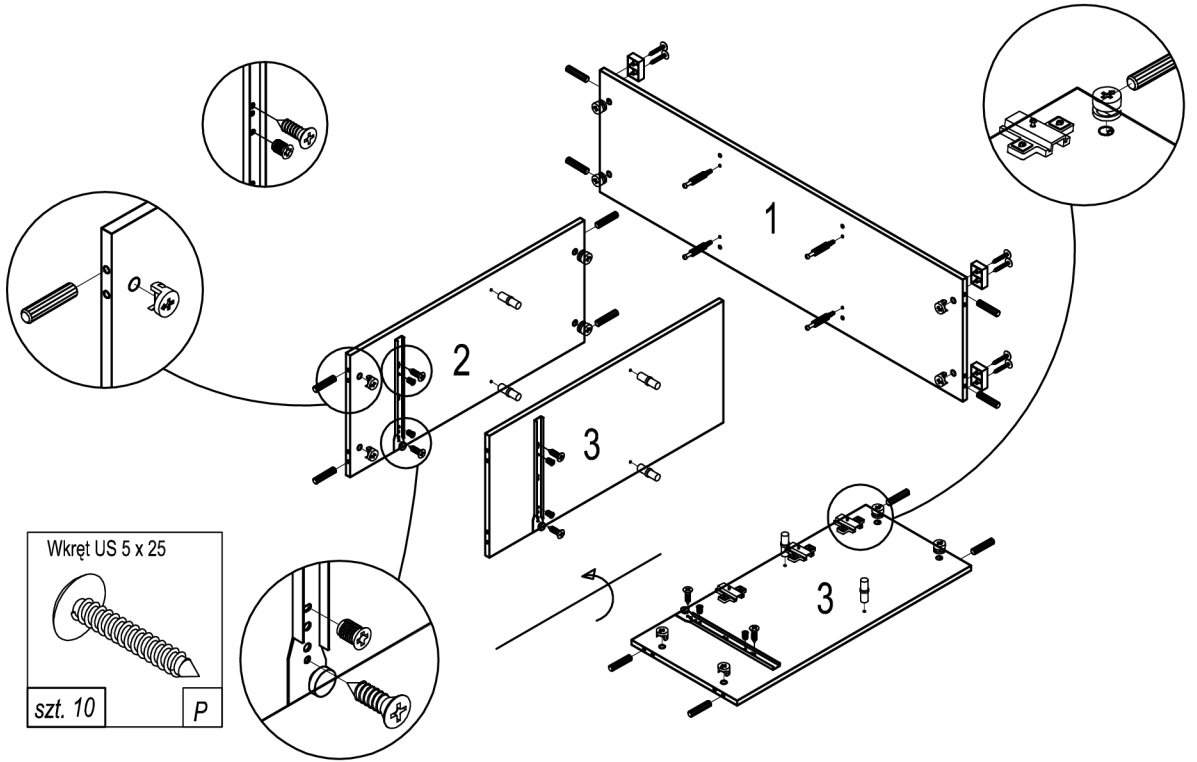
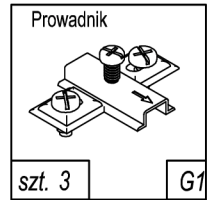
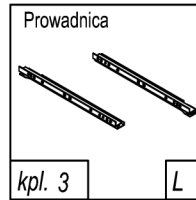
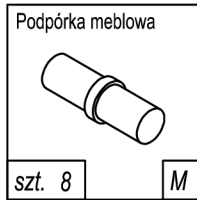
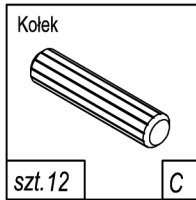
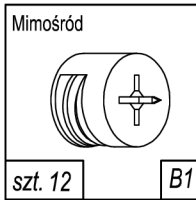
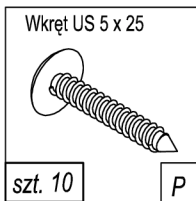
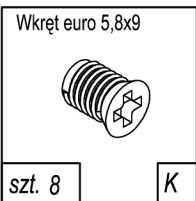
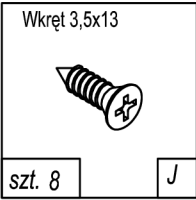
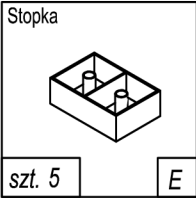

3

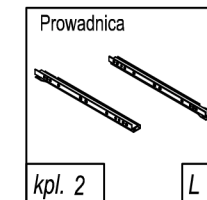
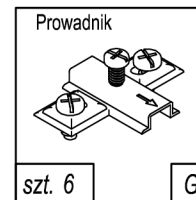
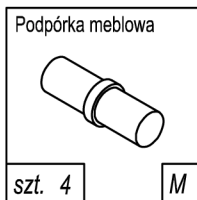
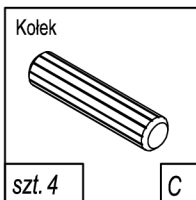
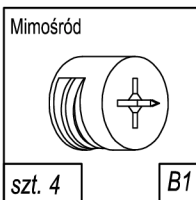
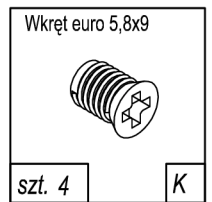
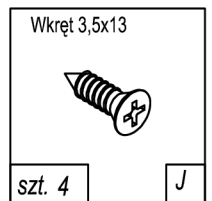
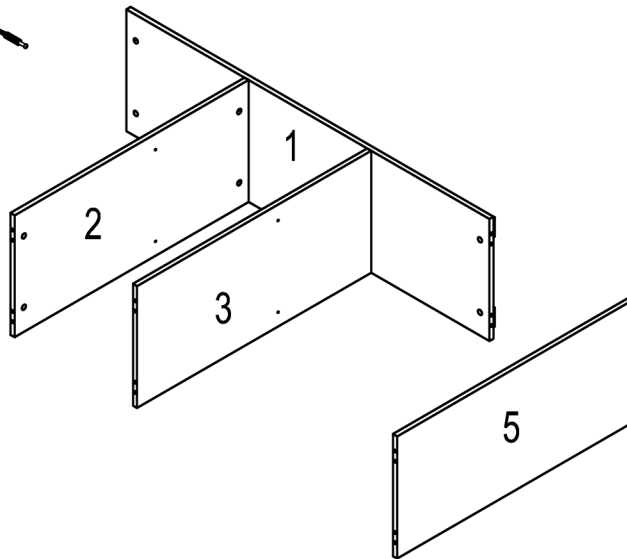
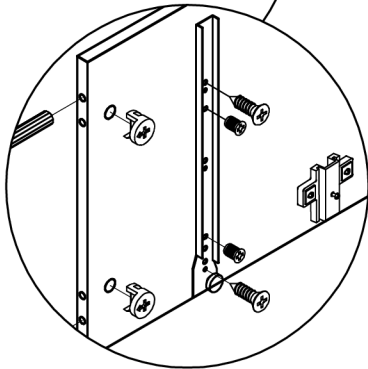
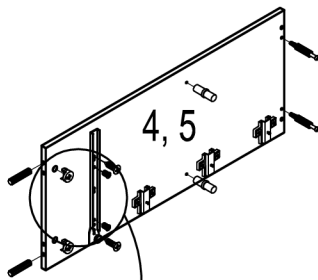

4

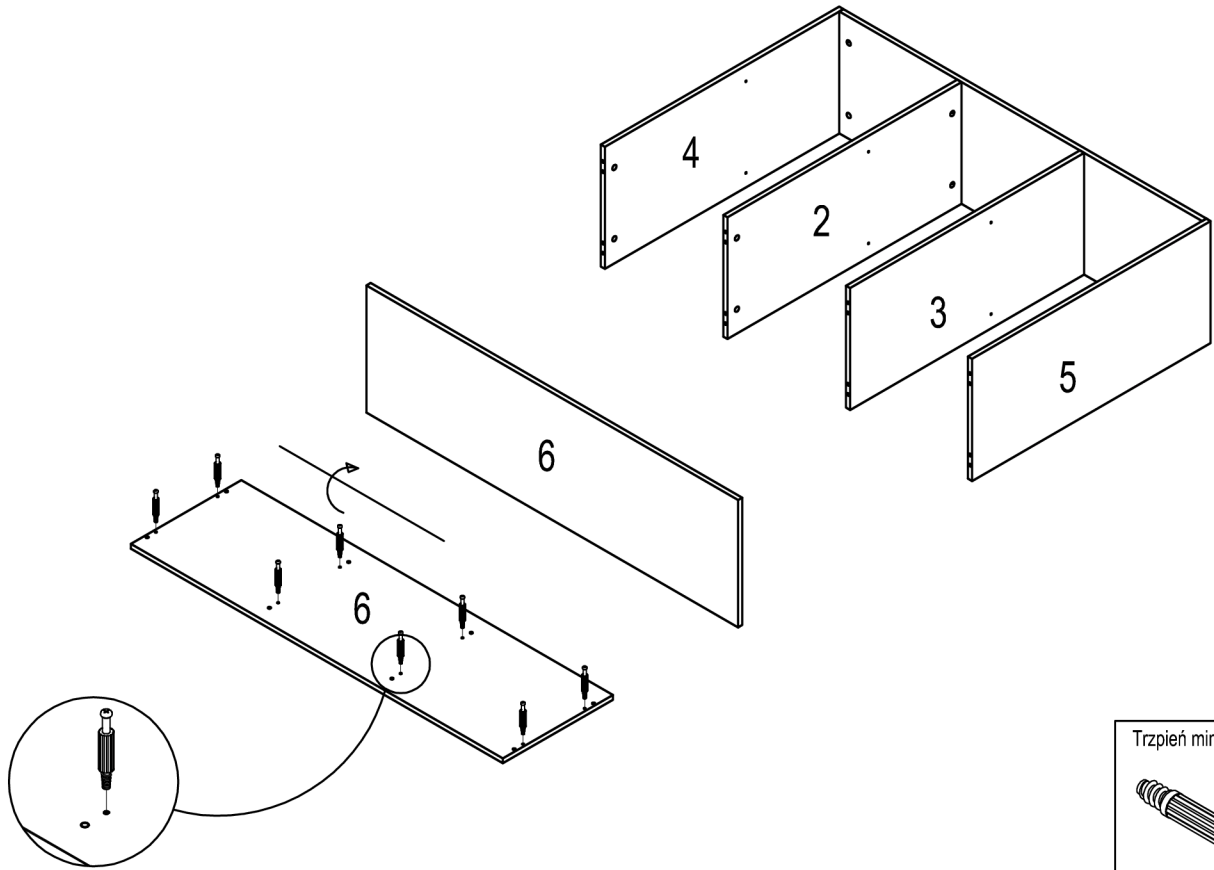

Trzpień mimośrodowy
 szt. 8 A

5

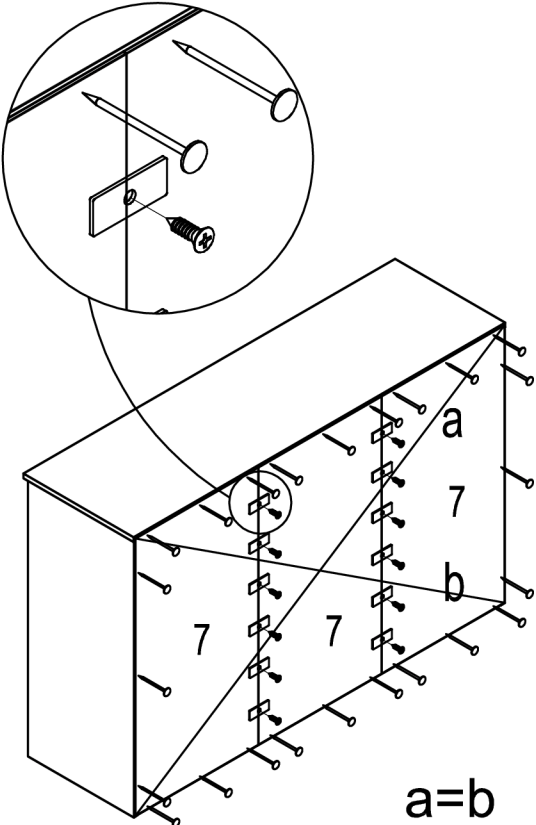
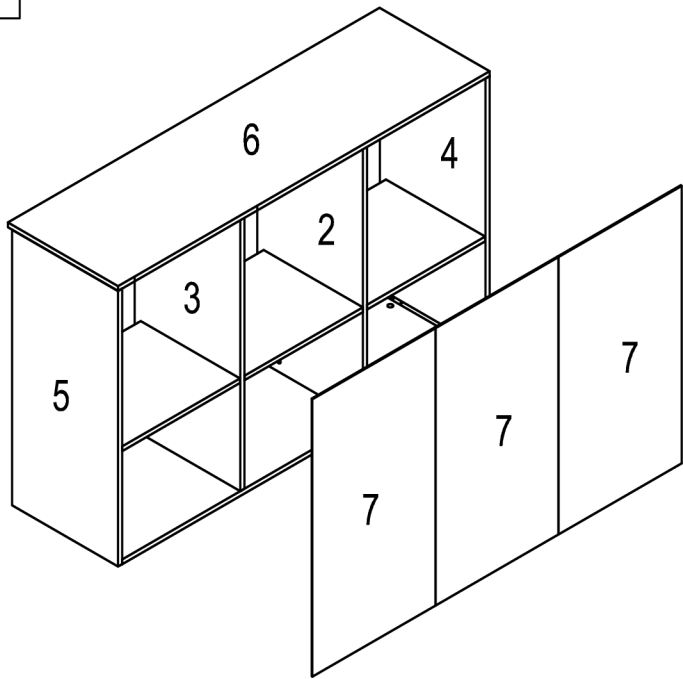

Błaszka łącząca
 szt. 12 I

Wkręt 3x16
 szt. 12 F

Gwoździe
 szt. 50 N

a=b

6

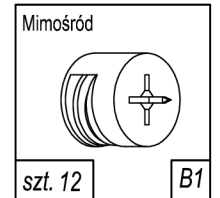
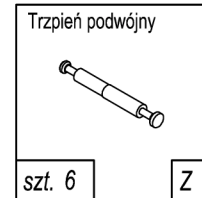
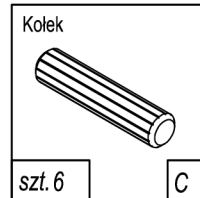
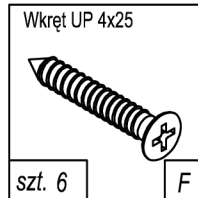
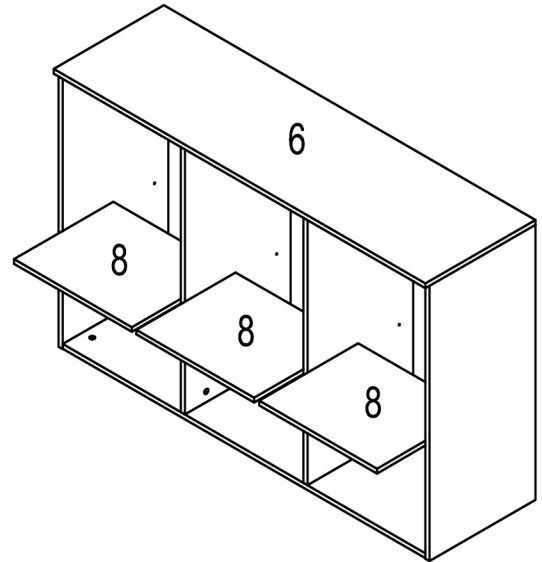
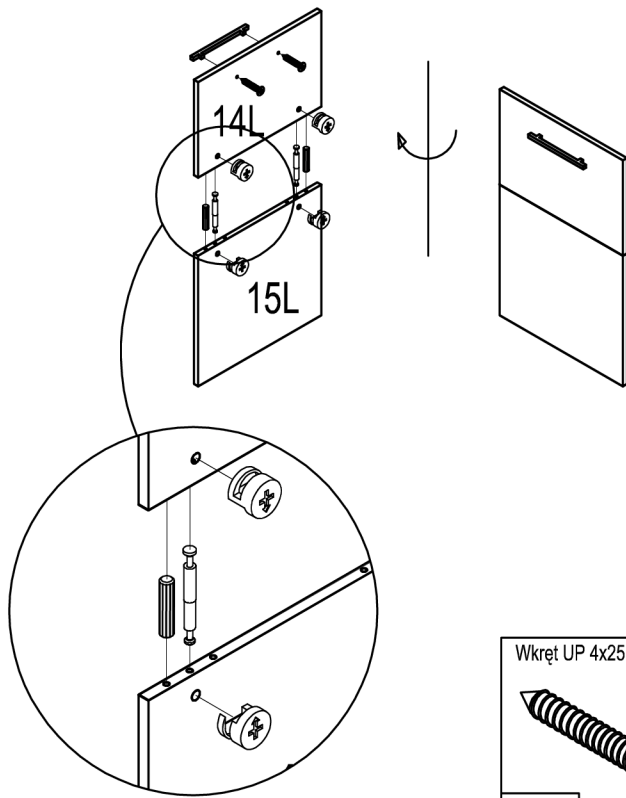

7

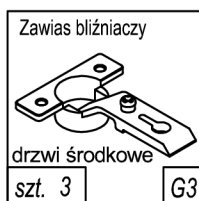
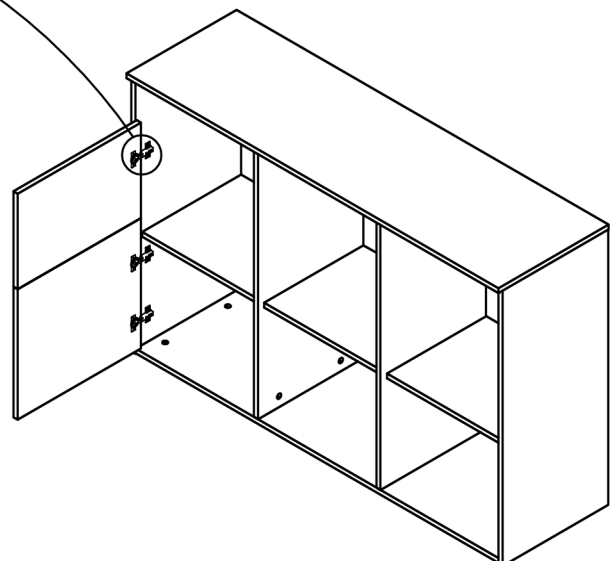
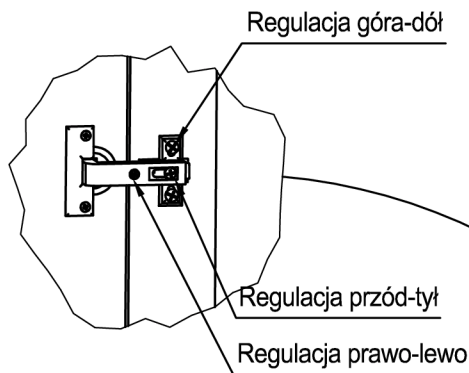

8

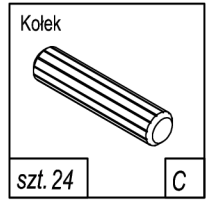
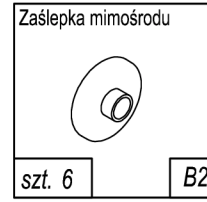
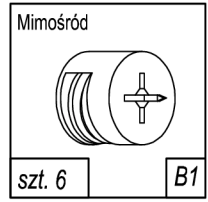
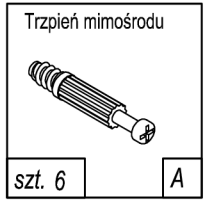
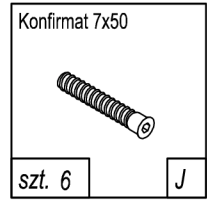
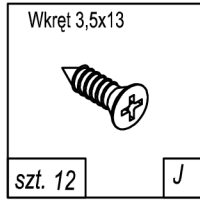
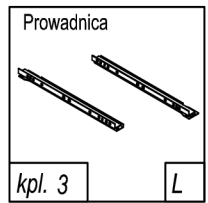
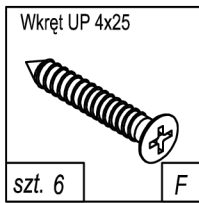
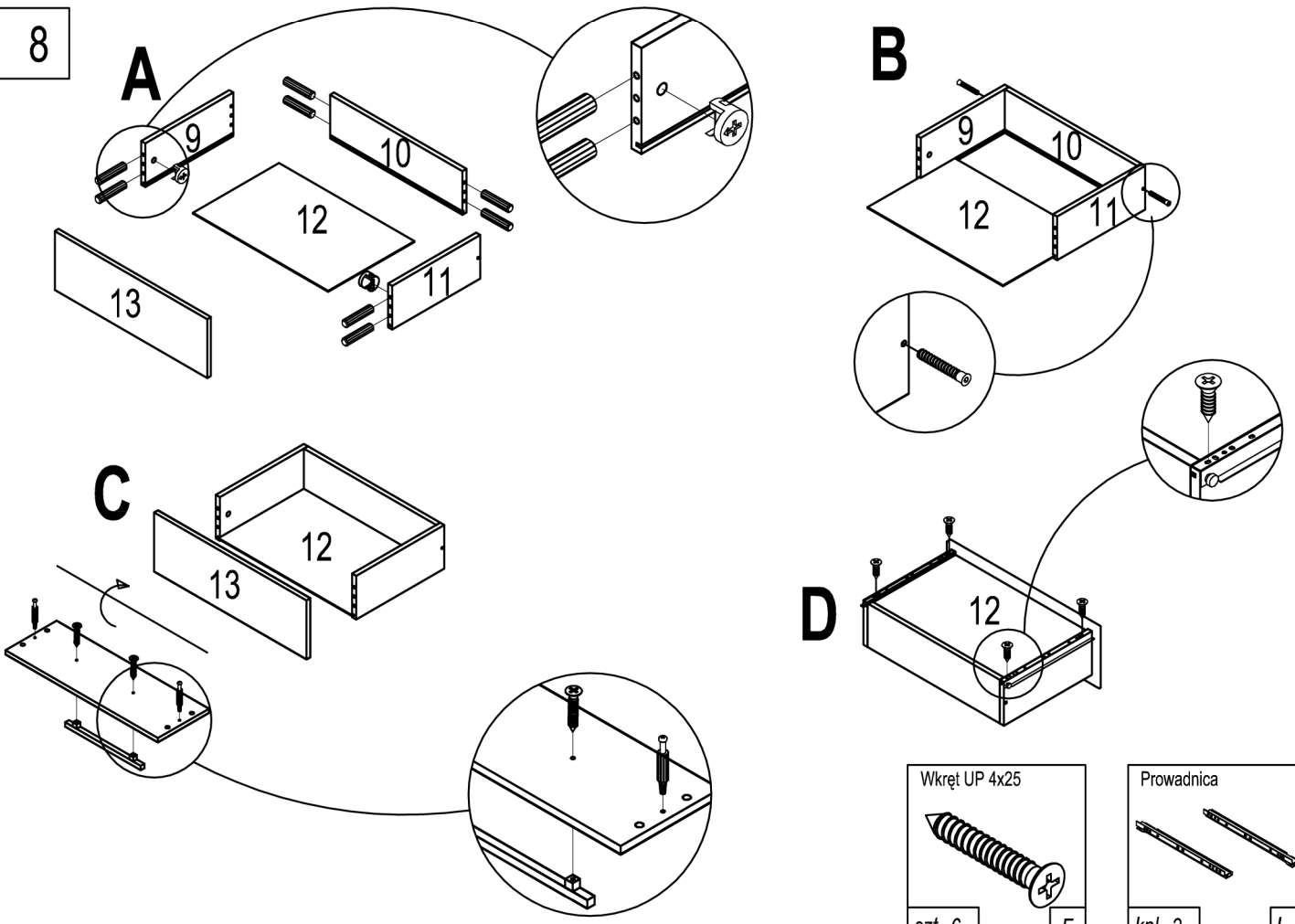

9

